



#WC85 DOOR CLOSER INSTALLATION INSTRUCTION

THIS INSTALLATION INSTRUCTION IS PREPARED TO PROVIDE YOU INFORMATION ON HOW TO INSTALL AND ADJUST DOOR CLOSER CORRECTLY. READ OVER THIS INSTRUCTION CAREFULLY BEFORE INSTALLATION TO ENSURE SAFE AND TROUBLE FREE OPERATION OF YOUR DOOR CLOSER.

1. DIMENSION CHART

Select one type to fit in with the door and frame.

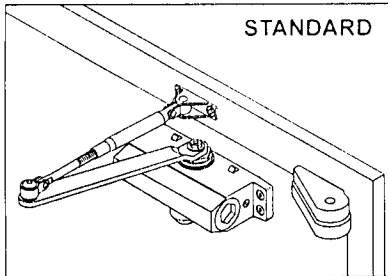

Installed on hinge side of door.

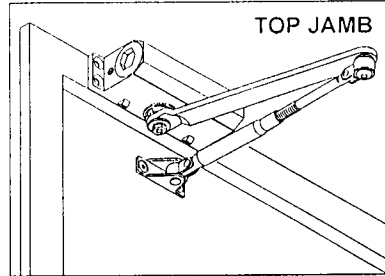
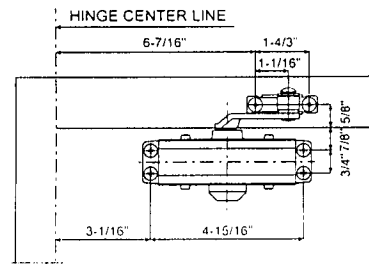

Installed on lock side of door.

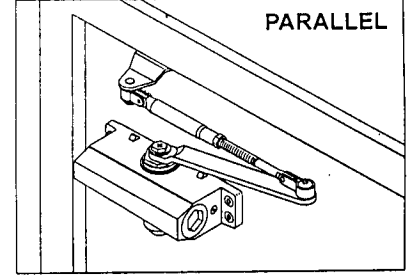
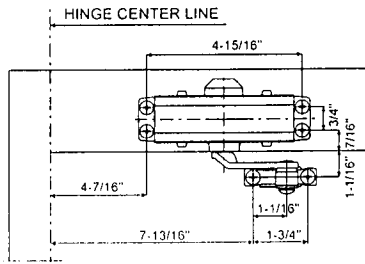

Installed on lock side of door.

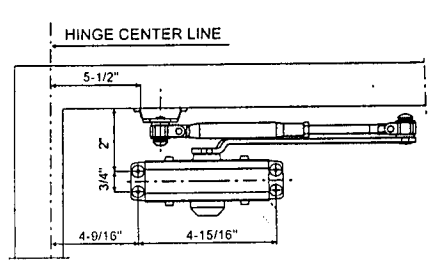

2. CHECK DOOR HANDING

This door closer can be applied to both right hand (RH) and left hand (LH) door opening. Before installation, check the door opening by referring to illustration shown below.

NOTE : For parallel application, remove the link shoe and replace with bracket.

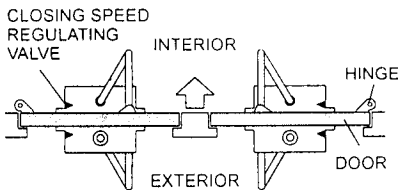

(LEFT HAND DOOR) (RIGHT HAND DOOR)

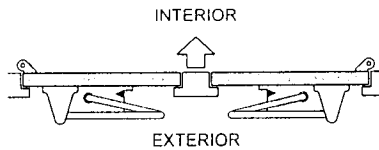

(LEFT HAND DOOR) (RIGHT HAND DOOR)

3. ADJUST CLOSING FORCE

Closing force can be changed by turning link shoe 180° before installation.

The longer distance from link to hinge center line will make closing force weaker.

The shorter distance will make closing force stronger.

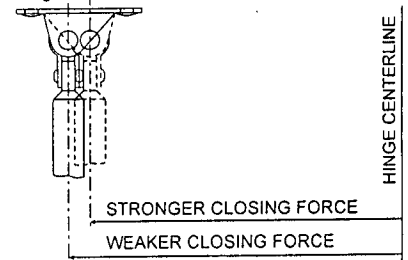

4. MARK ON THE DOOR AND TOP JAMB

Place template along door edge. Use a hammer and punch to mark the center of each screw hole then remove template.

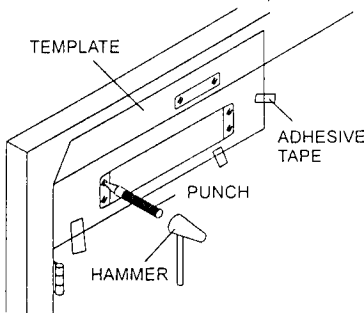

5. DRILL HOLES

For wooden doors, drill pilot holes #14 (diameter 5mm) on door and frame for wood screws.

For metal doors, drill (diameter 5mm) holes and tap 1/4"-20 UNC for machine screws.

CAUTION: Don't drill holes all the way through door.



TAPPING SCREW (FOR WOODEN DOOR)



MACHINE SCREW (FOR ALUMINUM OR STEEL DOOR)

6. ADJUST SPEED

Turn valve clockwise for slower latching speed, counter clockwise for faster latching speed.

STANDARD APPLICATION :

The position of the hold-open begins about 80°

PARALLEL APPLICATION :

The position of the hold-open begins about 115°

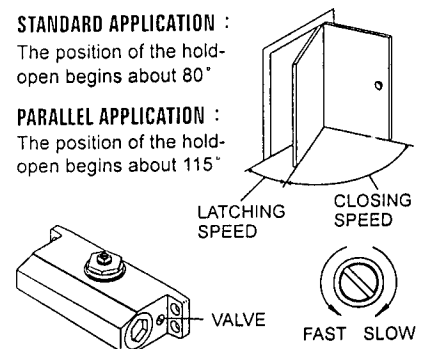

7. CONNECT ARM WITH BODY / FIX BRACKET

Match the square hole at end of arm with the square part of pinion then tighten with arm screw.

For parallel application :
Fix bracket first. Make sure bracket does not interfere with weather stripping.

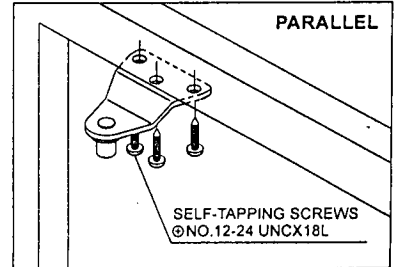
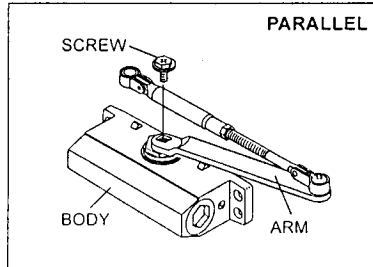
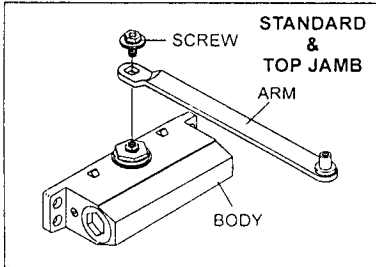

8. INSTALL BODY

STANDARD INSTALLATION:
Mount body on door to match the holes then tighten securely with 4 screws.

TOP JAMB INSTALLATION:
Mount body on top jamb to match the holes then tighten securely with 4 screws.

PARALLEL INSTALLATION:
Mount body on door to match the screw holes, then tighten securely with 4 screws.

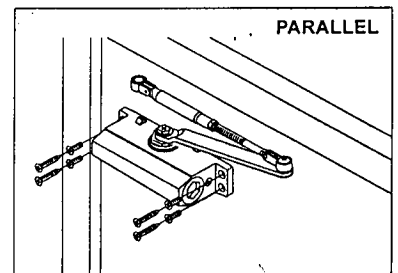
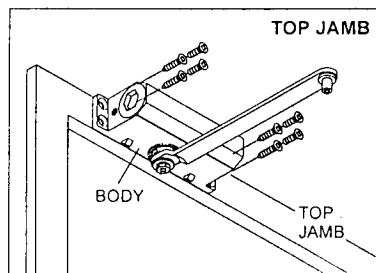
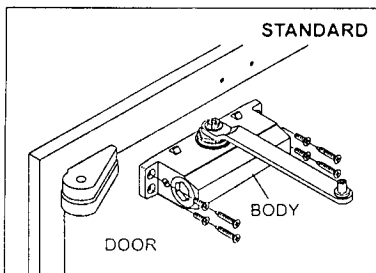

NOTE: FOR METAL DOORS 1/4"-20 UNC X 19L Ø HAED MACHINE SCREWS. FOR WOOD DOORS Ø 6 X 30L Ø HAED WOOD SCREWS

9. FIX LINK SHOE

STANDARD INSTALLATION:
Fix link shoe on top jamb to match the holes and tighten with 2 screws.

TOP JAMB INSTALLATION:
Mount link shoe on door to match the holes and tighten with 2 screws.

PARALLEL INSTALLATION:
Keep the link to be parallel to top jamb, rotate the arm and adjust the length of the link in order that the end of the link can join the bracket, then tighten with screw securely.

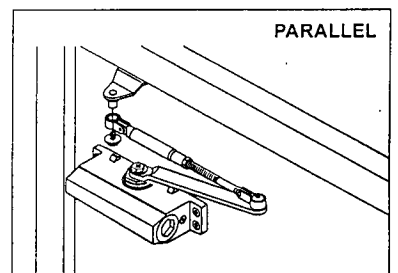
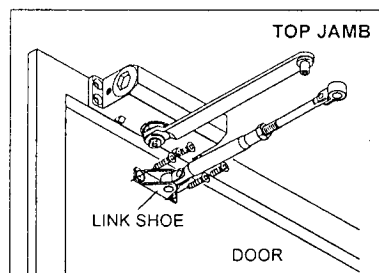
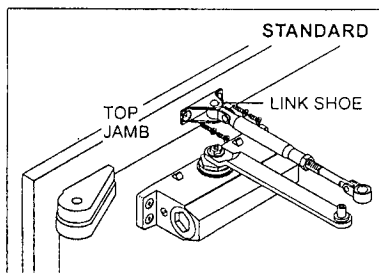

NOTE: FOR METAL DOORS 1/4"-20 UNC X 19L Ø HAED MACHINE SCREWS. FOR WOOD DOORS Ø 6 X 30L Ø HAED WOOD SCREWS

10. CONNECT ARM WITH LINK

STANDARD INSTALLATION:
Adjust link to be vertical to top jamb then connect arm with a locking screw. Snap closer cover over closer body.

TOP JAMB INSTALLATION:
Adjust link to be vertical to door then connect arm with a locking screw. Snap closer cover over closer body.

PARALLEL INSTALLATION:
Tighten the nut on the link. Snap closer cover over closer body.

